

The Forks -  
First lecture

*Republic of the Valley*

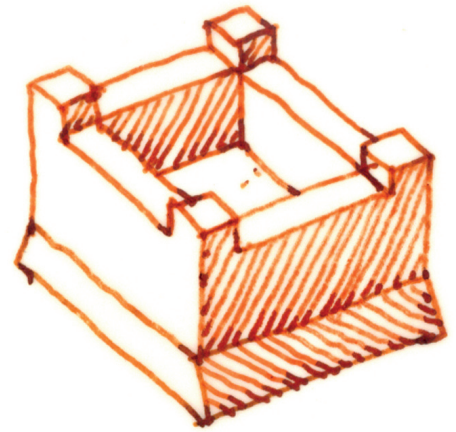

## FOR THE MOMENT I WILL REALISE THE IDEA OF THE CITY BLOCK AS THE 'HANDY SQUARE' THAT I DESCRIBED IN LECTURE XXII.



This was descended from a real project, that of Haverleij, near Eindhoven, in the Netherlands. The idea of marooning city-blocks like picturesque ruins in a park was a pleasing conceit. But there were, sadly, too many Architects in the large-scale Developers, Bouwfonds, for them to allow JOA direct access to their in-house sales team. We were not able to talk the sales-team through our concept so that they would understand that although the Handy-Square looked, at the small scale of initial drawings, like the mid-20C social housing, with open access decks, from which Bouwfonds themselves descended, the reality would be more like a monastery with an arcaded walk around an English garden square. Architects have always been a problem for JOA. Their self-fulfilling Modernist determination that the Future can only be born out of the corpse of the Past has been a main impediment on the 20C's ability to use 'Architecture' to solve the problems that their project of *L'Architecture Autre* can not.

As proof of their mistake in keeping JOA away from the people who directly sold their huge output of dwellings, I bring evidence from their own country that was already in existence when they exercised their mistaken 'Modernist Architect's taboo'.

I will first 'draw' my idea of what a 'whole city' could be as a diagram. But my symbols for its parts will be 'realistic'. My basic city-block is derived from the 'Handy-Square'. So I draw its corner-towers and its double-volume 'hand-working ground' as a 'battered' Khumba-base.

## It took JOA a long time to realise the little development of the Groenmarkt.

'Groenmarkt' means the 'greens', or Vegetable, Market. It is in the the oldest part of Den Haag.

The Aesthetics Committee, staffed only by Architects, hated its Classical 'look'. They pleaded with JOA to 'do something in steel and glass'. They argued that "the light in Holland is quite different to that of England". In reply, I tried to persuade them that the Netherlands of old had big windows because, being so early devoted to the banking essential to the trade at which they were the most proficient in Europe, they had need for the kind of reputation for solid wealth that accompanies the giving and receiving of credit. The large windows were there so as to allow their fellow-citizens to see that very Dutch combination of spartan living together with the accumulation of costly furnishings and objets d'art that are the universal sign of a household devoted to sound business ethics.

The newspapers, when the design was finally passed by the Authorities, speculated, in a generally favourable review, that the "Architect might be on drugs". For a Dutchman to learn from the past, must he be narcotised?

I had understood, when it came to be built, that it was the custom on Dutch projects (as it was in the USA), to allow the building contractor to make observations upon the technicalities. In the case of JOA's small building our Dutch Project Manager refused to allow it. His explanation was not that the technical details were perfect but that the building was so extraordinary that it was pointless to even try to 'rationalise' it.

JOA flew the short 'hop' across the Channel many times over these six years. But such was our Dutch Project-manager's 'fear and loathing' that he failed to make the reverse crossing even once - he never saw how JOA had built similar buildings, both larger and smaller, with great economy, many times over. He failed to grasp that JOA never used the 'plattenbau' method of construction so common all over Northern Europe - and Holland.



Our addition, which is to the right, abutted directly upon the 17C Town Hall. The hugely vaster population of the City Administration had been removed to the Richard Meier replacement; in which so bright was the light reflected from his white enamelled steel walls that dark glasses had to be worn indoors. All that one could now do in the 17C interiors, with their stained glass armorial windows and black and white checkerboard floor, was to get married. But then the centres of all the old cities of Europe have now become a theatre in which the young briefly sport and mate, to soon revert to the bungalow suburbs from whence they must now come. Our addition was aimed for the other cult of adolescence: shopping.

# JOA had always used, for 20 years, a light steel frame.

Especially was this so on a merely two storey structure. Steel goes up fast. Developers like that. I learned this in 1976 on a warehouse costing 110/sq. metre. Nor, as opposed to concrete, does steel shrink as it ages. But the main reason why JOA used steel was is that it allows us to erect, very early, the heavy precast pieces, the capitals and 'logs', that constitute our Entablature. We had learned, back in 1976, to put the roof on before the external walls. Doing this enables one to start, as early as possible, on the internal fit-out - usually the most complicated, and often the more costly, part of a new building.



The 'Working Order' seen from the inside is all usable space because steel is thin and strong. The brick cylinder was self-supporting for 25 metres on the Judge. Two storeys are nowhere near its strength limits.

Getting on with the interior early also allows the builder time to hand-lay the external walls. It takes them off the 'critical path' to the completion of the whole building. Making them of hand-laid brick also allows the builder to make up any slight discrepancies between the placing of his big, fixed, elements - like windows. Brickwork is easily 'stretched' dimensionally, by slightly increasing or decreasing the size of the wet mortar joints. It is all very convenient and it had all been known to JOA during twenty years of practice.



The Modernist is compelled, by his ontic pusillanimity, to reverse the physical logic of building. He makes his internal structural skeleton of 'heavy masonry' (ie. concrete) and his mutely lockjawed facade of useless glass. In our case this meant the internal duct-space was choked-off with superfluously huge concrete pillars. In the Judge a fitter could climb up the inside of a Robot-column of this size to service lights and gondolas.



'The Dutch Way'. Plattenbau over everything. The only JOA robot columns, in 23 years, that were useless for servicing from the interior! They were filled with pre-cast concrete! Ironically, it was this pre-cast, which no-one sees, that prevented the early erection of the JOA Entablature of blue logs, black caps, etc.. No Entablature = No Roof. No Roof = No Interior for six months. A failure of the builderly imagination - by the Project Manager.

It is possible to stand inside a light structural steel frame and bolt onto it a seven-ton pre-cast concrete Entablature that is hung from a crane outside it. But if one is separated from the object of one's attention by a wall of solid concrete, it becomes impossible to either see the chunk of concrete hanging from the crane-hook, or to reach through the wall to pull it onto its bolts. The Dutch Project Manager was secure in his foreknowledge of what constituted practical and cost-effective building. He knew, instinctively, that the Groenmarkt design was a mere folly. It was a multi-coloured 'Greek Temple', promoted by the millionaire owner of his Development Company, to grace his home town of Den Haag. So the Project-Manager ordered a standard Dutch 'plattenbau' box, and stuck JOA's 'architecture' onto it as an incomprehensively self-indulgent, 'merely-decorative', trimming.

The result was that, because the 6th Order Entablature could not be bolted from the inside onto its structural frame, its giant pre-cast pieces had to be put on after the elaborate polychrome glazed brick external walls were built. These walls were built with a splendidly craftsmanly precision. The bricklayers used stainless steel 'rods' engraved with the mortar widths of the course-heights. It took weeks and weeks. But the roof could not be begun until JOA's Entablature had been erected. The interior was delayed for six months in an 18-month build. It was the largest delay in JOA's entire career. It added 30% to build-time. It was a financial catastrophe for the Contractor, whose legal responsibility it had become. The Technical University of Delft made a study of our building. They concluded that the Architect should not be allowed to design without the input of the Contractor and Project Manager. They made other derogatory



*I was suspicious of the Marbra-Lys blue, when it arrived on site. It was too blue. I was right.*

remarks concerning Architects. It goes without saying that Delft never, once, in six years, asked to talk to anyone in JOA. Academics are fools when it comes to Practice.

If there is a novelty for which JOA are known it is the invention of the Robot Column, or the 'Working Order'. So careless was our Project Manager of the utility of this invention, let alone any symbolic quality it had from being an 'Architectural Order', that he showed no interest in using our giant 1.8M quatrefoil columns as service ducts. He allowed their interiors to be so filled-up with the concrete of his massive 'plattenbau' building-system that they were useless for vertical, or even horizontal, services. The internal Entablature of the Rotunda, which was planned to receive a colourful inscription, leading up to a circular printed ceiling, is now painted black in order to disguise the presence of surface-mounted, boxy, electric cable-ducts.



Light and Matter coincide in a 'photolith', as I call JOA's architectural components. The logs of the 'floating raft' of the JOA Entablature, with its fluid spirals of airy foam, is coloured all the way through. But only one blue is fast.

**DURING THE BUILD, THE SUPPLIER OF THE BIG PRE-CAST ELEMENTS USED A PIGMENT FOR THE BLUE CONCRETE THAT HE WAS EXPRESSLY BANNED FROM EMPLOYING. JOA HAVE KNOWN, SINCE 1984 THAT THERE WAS ONLY ONE BLUE PIGMENT THAT IS COLOUR-FAST IN THE ALKALINE ENVIRONMENT OF CEMENT.**

**IT IS A COBALT BLUE MADE BY BAYER.**

Bayer's testing fields were a mere two-hour drive from Den Haag into Germany. This same pigment was specially imported 6,000 miles into College Station, where my blue concrete was cast in Texas. In Belgium, Marbra-Lys used pthalocyanine blue. The result is that all of the blue concrete, with or without white spirals, is now, ten years into the life of an 100-year monument, a dull, dull, grey.

I designed, for the sake of economy, only one pre-cast element on the Rotunda which is 'curved-on-curved' work. When you want to impress a consultant with the depth of your Client's pocket, tell him he is not afraid of 'curved-on curved work'. Everything else on the rotunda facade is straight when looked-down-on in plan. These are the big white arches. They are curved on elevation and curved on plan.



Ten years later all the blue concrete, with or without inlaid white spirals, is grey. Even the glossy black capitals, supposedly made of black concrete and then clear lacquered with xylene, was merely grey concrete painted black - which has now washed off.



The previous picture, and this one, shows the big white arches.. Marbra-Lys cast the arches in two halves, with their faces laid flat on the floor. They come to a feeble point, when seen in 3-D, rather than a proper half-circle. The contract drawings showed the arch to be 'curved-on-curved work, rounded on plan. Again Marbra-Lys cheated, the Dutch Architects, INBO, ignored the fault and MAB did nothing. JOA were not even allowed to inspect the castings.

**This inconvenienced Marbra-Lys. So they laid their two faces flat on the casting-bed when they chose to cast them in two halves. This made them into a series of straight lines when seen on plan. When erected in three-dimensions, these big white arches come to an inconclusive point that is neither Gothic, nor 'Roman'. They just look like the mistakes which they clearly were. Both of these severe transgressions had been clearly drawn and specified. Neither of them had been noticed by Inbo, MAB's Dutch Executive Architects.**



I invented a little mural to go over the entrance to the underground Bicycle Park. My Dutch Project Manager redeemed himself by getting it made very nicely. The blue frame sets off the yellow star.



But, ten years on, Marbra-Lys's wretched pthalocyanine blue pigment has washed-out, as has their non-black black concrete. JOA's spec. was clear, and based on long experience. Who allowed the Bayer blue to be substituted?

**Both of them were squalid, miserable little economies which meant that for JOA, at least, the appearance of the Groenmarkt was so deeply damaged that I refused to publish it in any serious journal. When they were discovered, one by one, JOA informed our excellent Client, a very amiable and civilised man who now lives in a castle on the French Riviera with his considerable collection of Modern Dutch Art. But the project was already very behind schedule and there was no possibility of any positive restitution. JOA just took our fee, what photos we could and left, knowing that JOA's first building on the 'Continent', because of this dismal lack of care, would probably be our last.**

Imagine my surprise, then, when JOA received a call, ten years after the very jolly opening party, from the Firm of Sting, the tenant of the Rotunda itself, along with the whole upper floor of the Groenmarkt block. It was to tell me that our little building, which the Public had immediately nicknamed the Snoeptrommel (meaning Candy-Box) had been built, at 1:15th scale, in a miniature city which contained a complete microcosm of everything the Dutch public thought of as quintessentially Dutch.

I was to be invited over to unveil this miniature, along with the Mayor of Den Haag and other politicians. This 'City of Holland' was not at all like the twee little mini-village in Beconsfield, Britain, that merely played to our deathless insular myth of rustic bliss.

There was Schipol airport, with roaring jumbo-jets taxi-ing around. There was a football stadium with a shouting crowd. The Concert Hall played classical music through its windows. The giant, lock-gated, canals passed ships and the railways and trams whizzed around this city-collage of the concrete reality of the Netherlands. Everything lit up and night and there was a big, black-glass shiny monolith of some administrative slab block next to a moving-around building-site with cranes etc.



Looking the other way shows the more 20C side of Madurodam. The control tower of Schipol, with creaming Jumbo-jets, lies to the left with, behind it, moving bridges and the big canal cargo-ships. A mother and two children loom Gulliverishly.



Madurodam was built, after WWII by the Maduro family to commemorate George Maduro who, born in Curacao, died in a Nazi labour camp. It reproduces all that is famous, loved and yet 'real and authentic' about the Dutch lifespace. Its profits go to charity. I found it intensely moving to have my Groenmarkt included within this Netherlandish Valhalla.

As the leaflet said: "If you have only one day to see Holland, come to Madurodam".

So what was going on?

I asked how my building had been chosen and was told that it was a combination of the Management of the miniature city-scape and the Politicians, who had judged the building 'beloved' enough to admit to this Vallhalla of the Dutch lifespace. I was enormously pleased. I had known that the Public liked my buildings in Houston, Cambridge, and London as much as my colleagues, especially the academic ones, hated their "Breaking of the Taboos of Modernism".



The Mayor of Den Haag is a sixteen-year-old. He stands with his back to Marco van Muiswinkel, of 'Sting', who talks to Rima, my wife. I told him the 1:15-scale miniature was better-made than the original. How could he know I was not really joking? Its colours will be more 'fast'!

But I had never imagined that the same **clash of sentiments** would obtain, to an even far greater extent, on the Continent of Europe, that cradle of the Modernity I both admired yet had sought to reform. I was truly touched that Holland, one of the original founts of Modernity, had recognised that JOA's work was not just a regression to 'Hellenism' but stood for something new that was, at the same time, not destructively ignorant of history. And all this had been put into motion on a building that I regarded as almost irreparably damaged by a building culture which was so rigorously committed to an illiteracy that its leading Architects virtually led the world with their skill in avoiding any continuity with Architecture as it has been understood for the 9,000 years of its history.



Sting, the Tenant of the First Floor, bought-out all the Ground floor shops but one. So the polished concrete base, well-made by Marbra-Lys, was kept waxed and painted. It is at ground level, so they treat it as their own. It is now Sting's 'flagship' store in Holland..



My first question to MAB, the developers, was "do we need windows". I knew shops blocked them up above the Ground level. The answer was "No". Den Haag's city-planners did not agree to my proposal for Murals. So Sting just filled them with their 'house colour' - a red that, fortunately, worked well with my Groenmarkt palette.

The inclusion of JOA's Groenmarkt within the Dutch Valhalla that is Madurodam (for it also contains the Rietvelt-Schroder house) was for me a signal that it might really be possible to turn the rudderless juggernaut of a conceptually-bankrupt Modernity, and point it in the direction for which I argued. It proved that the Public, and its representative Politicians, still loved what it was that the medium of Architecture could do for them, even though not much of it yet made much sense.

Architecture, as anciently understood was, contrary to my profession's determination, not (yet) dead.

# IT LIVED-ON!

I have told the story of the Groenmarkt neither to chastise those who injured it, nor (though I am grateful to them), to publicly thank more than I have already, those who elevated it to its unexpectedly high status. My objective is to encourage those of my listeners who attend most closely to the contemporary fashions in what the Trade Press, with ever-increasing diffidence, still calls 'Architecture'.



For the evidence of my 55 years in this medium is that, for almost the whole of this time, those who run the Academies of Architecture have spent by far the better part of their, and their young charges, energies exploring an endless maze of blind alleys in the hope that they could escape from their proper task - which was to modernise the ancient medium so that it could be used, today and in the future, to solve many of the most pressing ecological, and political problems that face us today.

The 2009 Post-Graduate work at my alma mater, the Architectural Association school in London. Not one work, in the whole year's work by 600 students recalled the medium of Architecture. Only one bookshelf of its famed 'Triangle' Architectural Bookshop', sported texts on buildings older than the 20C. Not only was Architecture dead, but its History with it. One might christen this the Work of the Year 'MELTED-INTO-AIR' P.D. That is to say 'Post Digital'.

It is this failure to theorise Architecture in a way that 'works' for us now that is the broken foundation under the final collapse of Architecture, and consequent upon that, the continuing disaster of the inability to plan cities that marks the inhuman livespace left behind by the 20C. No alternative exists today but to propose new Architectural theories of radical clarity.

**The Academies, pursuing the Counter-Formal and Contra-Functional Delights of 'Architecture Autre have "Melted Architecture into a Baudrillardian Air".**  
**AGAINST THIS I OFFER THE 'CUBIC SOLIDITY' OF A HANDY-SQUARE'.**

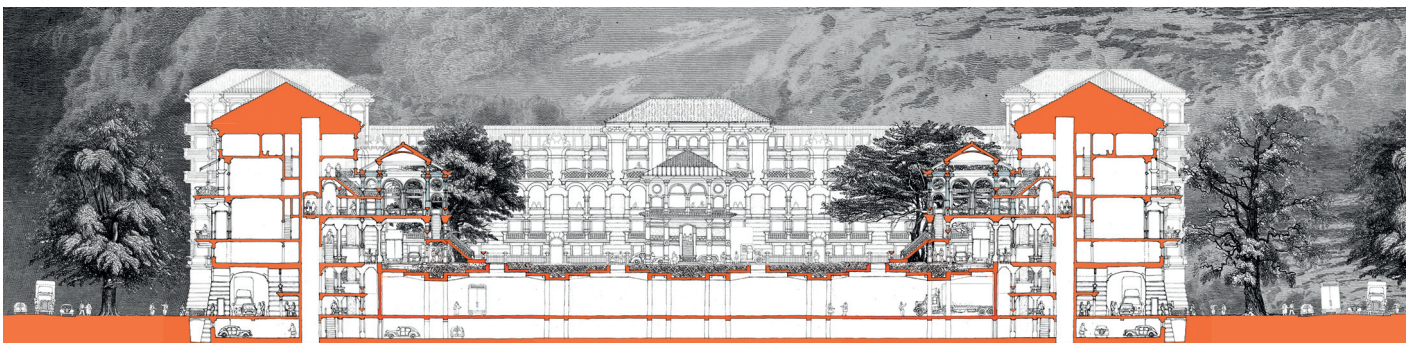

The terminal iconic illiteracy of 21C Modernism can only conceive of the city-block as an iconically featureless 'box' from whose destruction-by-digitised blasting-away Mankind will win a new freedom. My listener may return to Lecture Twenty-Two to refresh a campaign-strategy that does not leave every new development strewn with structures uncannily akin to the aftermath of a massive terrorist attack! Death need not be the New Freedom!

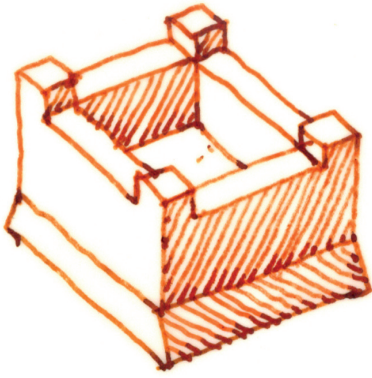

The 'Handy-Square brings back both Residence and Work - the two 'use-classes' banished from the late-20 City. The Handy-Squares make-up the majority of Isola-Blocks in the Quarters of a 'Constant City'.

**I have already suggested that the Listener imagines the 'Handy-Square' as the typical 'isola-block', making-up the Hypostylar 'time before Time', of the Constant City.**

*The second sort of isola-block is the kind which lies along the 'fluvial axes. It must be both a 'block' yet penetrated by a River of Space that is the River of Somatic Time. I draw it, therefore as a cubic block, without that 'Handwork' base which lifts the Residential up into the clouds of verdant trees.*

**Large arched 'Doors' penetrate the walls of this 'Fluvial Block'. Through them can flow the River of Somatic Time.**

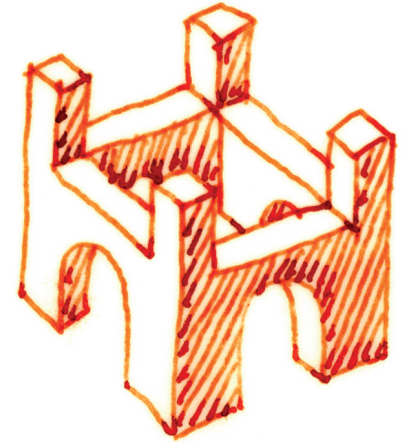

The second sort of Isola-Block is the sort which both accommodates and creates the River of Somatic Time and Sociatic Space. I title this sort a 'Fluvial Block'

There must be, evidently, **some loss of floorspace in a block with a big hole through it.** Although the hole, and the loss, will **appear smaller as more realism is brought to this diagram.** Against this remember that the **received alternative is a big, wide, empty boulevard with not only no rentable floorspace, but no floors, walls and ceilings** into which to **inscribe ideas.** I have already argued that the **Beaux-Arts Weave is a more sophisticated spatial culture than any of the others of the 20C.** What I now do is to **propose a new functionality for it, from the individual building all the way up to, in this lecture, the City.** This function is to **reify the Arendtian 'Space of Appearances' as it locates at each of the Event-Horizons along the 'Republic of the Valley'.**

*Each of these is figured, at the ideal, theoretical, level, as a Nine-Fold Square whose centre is the primary, 'epiphanic' stage. The three basic Events of the Delta, Confluence and Source, are figured by being composed from up to nine such 'fluvial' Isola-blocks of which the central one, depending on the climate, will transition from an open plaza to a cooled or heated enclosure, via a merely covered-over, market-type, structure. The other eight of the Nine-squares can relate to the central Ninth, both iconically and spatially, through one of the 'big arches' of the Fluvial type of block.*

*The Delta and Confluence are both 'transitional' events, along the flow of the River of Time. But the Source is not. Time, and the Space of the River of Time that is the Republic of the Valley spring from a single point. The spatial axes of such a place are necessarily vertical. This requires a model like the tholos tomb, or baptistery, to which we will later come. In the meanwhile I propose a simple development of the Fluvial, big-arch Block that will help demarcate the 'bed of the river', in one of the more commonplace, and conceptually trivial, ways advised by every mediocre 20C town planner - the 'tower block'. How, then, can we weave towers within our Beaux-Arts River of Time?*

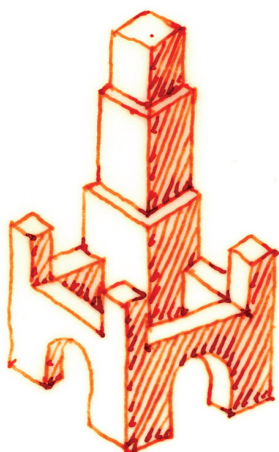

Fluvial Isola with a Tower to the 'North'.

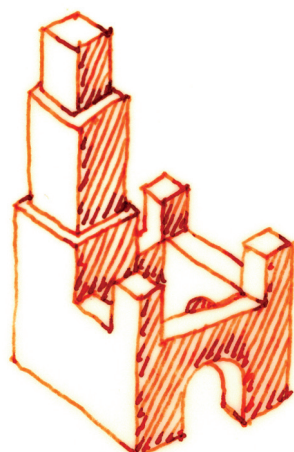

Fluvial Isola with a Tower to the 'West'.

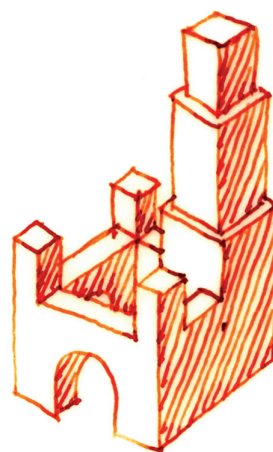

Fluvial Isola with a Tower to the 'East'.

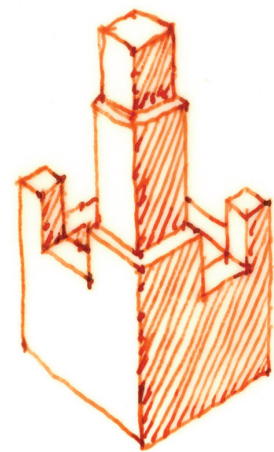

Fluvial Isola with a Tower to the 'South'.

① the body ② the chain of occluded processina. ③ The succession of 'Water-gates'

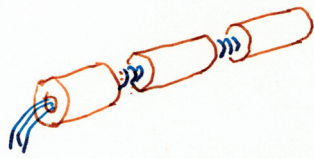

road surface

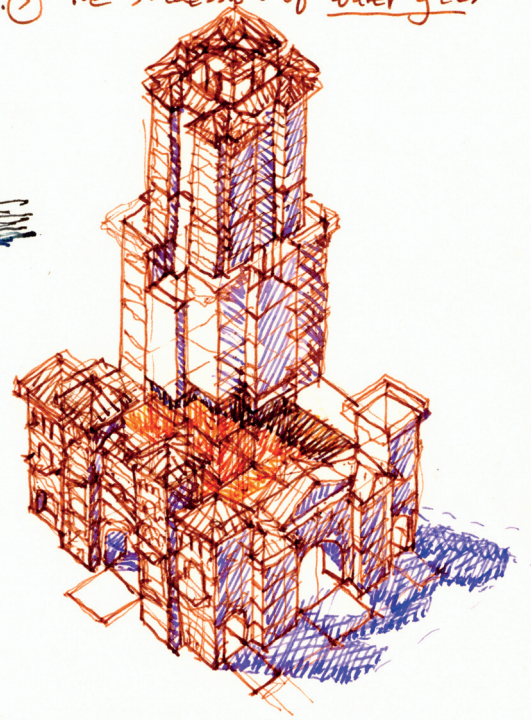
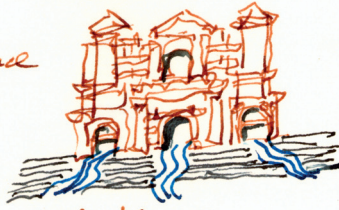

a single tower draws attention only to itself. A pair of towers draws attention (focus) upon the space between them. The two are urbane. The solitary is suburban.



The river flows through the blocks that stand on the 'Fluvial' axis. It penetrates them and strings them together like the beads of a necklace. The drawing meditates on how one tall tower merely draws attention to its-self, whereas two, like a rifle-sight, will draw attention to the space between them. The single tower is suburban. The pair of towers, which focus the mind on the space between them could, if the space is the honorific central room of the 'Weave', pass muster as Urbane. The drawing to the right shows how one of the 'Fluvial Plots' could harbour a taller tower than the usual corner-towers. These taller ones can, when they are used symmetrically, in groups of four, six, eight, or more, mark the major parts, like the Delta-City, the Confluence-Market or the Recreation-Nymphaeum of a whole Quarter. If the Handy-squares are like urbane Castles, the towered one has a 'keep'.



The Beaux-Arts Weave REPLICATES the Tower. Its Benjaminian 'aura' is destroyed, reducing its merely scalar prominence to iconic triviality. Their reduced, secondary, status can then properly frame what is between them:- the urbane Space of Appearances.

ONE OF THE CITIES THAT CONTAINED SUCH TWIN SKYSCRAPERS WAS NEW YORK, WHERE IT WAS WELL ESTABLISHED LONG BEFORE THE DESTRUCTION OF THE WORLD TRADE TOWERS.

The reason was the long-standing subscription of the USA to the Parisian Beaux Arts.

A block on Central Park West photographed with a pine tree placed so as to seem to be bracketed by its four corner-towers. Corner towers have many origins. All of them prioritise the 'invisible' interior which they mark-out. This is especially so if the towers replicate each other. It is even more so if they appear to have once been a single 'mountain'. For then they would have been 'sundered' by the advent of the 'Quadrations' in order to create the Interior Space of Appearances.

The only failure of Manhattan, as is the more contemporary one of Beijing, was that the 'twin-tower-mirroring' was not spread over the multiple building plots needed to achieve a 'res publica' at the scale of a whole quarter, and ultimately a whole city. It was practised only on single plots.



Looking West from the roof terrace of the Metropolitan Museum shows how the twin-tower skyscrapers (the San Remo) stand out from the shambles of the 'single-fingers'. It also shows how the eye, puzzled by the 'unnatural' replication, travels to the space between the towers. New York's failure, as is the later one of Beijing (which also built duos), was to achieve this mirroring over the multiple building-plots required to institute a public realm.



The twin 29-storey towers of 300 Central Park West 'Eldorado' apartments were designed by Emery Roth and built in 1931. Their base is a whole city-block. The towers are best seen from the Park itself.



The twin towers of the 1930's Central Park West 'San Remo' apartments designed by Emery Roth also stand on a high base that renders the towers mysterious by 'distanciation'. The forest trees cover the base from which the towers emerge.



The twin towers of 154 Central Park West and 72nd Street 'Majestic Apartments' developed by Irwin Chanin. Built in the last four years before the Wall St. Crash, this architecture had no time to gestate an 'urbane' theory. That remained for us to do!

**These coherent instances, from West Central Park, were all built between 1929 and '31. They stand-out from the chaos of 'singular' towers around them. They show the Manhattan tradition going back to that conjunction of Modernity and the Beaux-Arts which became the short-lived American Moderne.**

**URBANITY NEEDS 'THE BLOCK', BUT 'THE BLOCK' IS NOT A CITY.**

# A CITY IS A WHOLE THAT IS GREATER THAN ITS 'BLOCKS'.

Skyscrapers, as such, in single, all-by-themselves mode, are suburban. Urbanity demands that they be rendered secondary to the spaces that they 'mark' between groups of, at least two, of them.

The 'Fluvial' type of Isola-block can be bracketed by two of the same type but with 'Keep-Towers' in opposed corners to begin to mark out a larger whole that, in happening to occur at a denotable place in the overall fluvial narrative of the Space of Sociation, can then be inscribed to bring this Event-Horizon to mind.

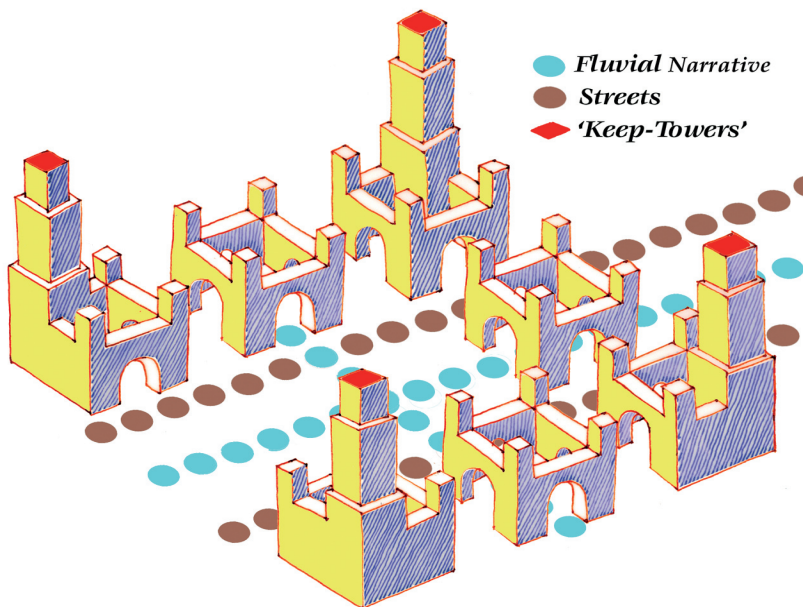

While two 'Keep-Towers' can mark the door-into, as well as the door-out-of, a Quarter, such as could be worked-up into an Event-Horizon of the 'Balcony of Appearances', four such Towers mark-out an urbane 'interior' that looks inwards upon itself. Flanking 'Fluvial Blocks' can reify its 'Public Realm' with tributaries of the River of Somatic Time' to constitute its 'Body Politic'.

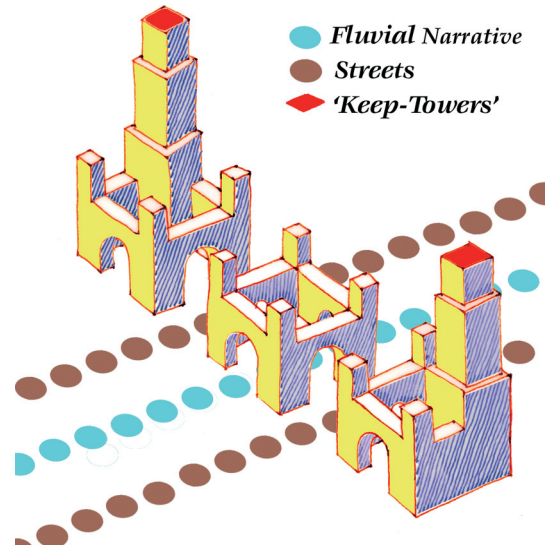

A diagram illustrating the idea of the fluvial block bracketed by two Fluvial Tower-Keep blocks. The Tower-Keeps are shown off-centre within the block itself. This allows daylight to enter into the block.

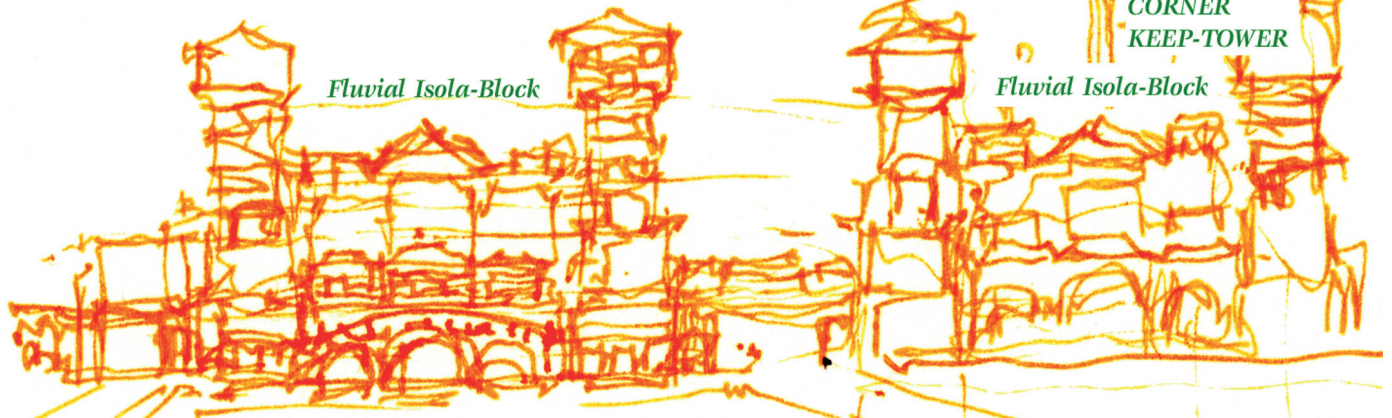

Elevation of the 'Fluvial Axis'. The block to the left would be the central one, with the Fluvial Axis running through its three arched openings under a 'Balcony of Appearances'. The Isola-Block to the right contains a 'Keep-Tower'. It would be mirrored with a similar block to the far left. The towers mark the 'Precinct' from afar.

The only other sort of 'Fluvial Isola-Block' is the one that the River of Somatic Time does not flow through.

This is because these are the places where the River of Association sources.

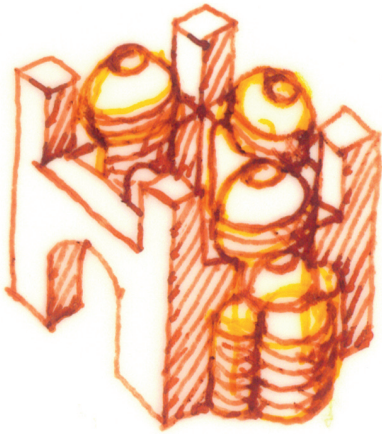

I have titled the third principal sort of isola-block 'Nymphaea'. The name is taken from the typical structures found at the 'source' of the 'river of space' that courses through the Fluvial narrative from the Renaissance onwards. I remarked the symbolic congruence between the chaste little 'faucet' drawn by Cram in the original plan for Rice shown in Lecture 28 (Writing the Outside), and the giant telluric orifice of the Stadium, lower down Page 5, built by the University in the 1950's. Such congruences prove the phenomenological permanence of the narratives elucidated in these Lecures. They are 'of Man' and 'in Man', and eradicated only by Death. What need is there for pseudo-Promethean labours of L'Architecture Autre when a decayed remnant of some Latin conceit can turn into an arena that pulses with the violent energy of youth?

The fourth sort of Fluvial Isola-Block is the one in which 'rises' the River of Space named after that of Somatic Time and the Time of Sociation. It can be a block including a 'Nymphaeum', as above, or the whole block as a Nymphaeum.

This Theatre of Origins includes, it should go with out saying, any and every sort of locus. There are the Ancient Religions that declare themselves so 'original' that they invent their own calendrical time - begining at their own 'year zero'. I may remind my listener of Hebrard's sadly-ignored 20C plan for Thessaloniki, which 'sources' its own Time of Sociation in, on the one hand the church of the Roman martyr Saint Demetrius, and, on the other hand, the more 'modern' project to recover Greece's Pre-Christian, Hellenic, inheritance with an open-air amphitheatre (Page 9 Lecture 32).

● Fluvial Narrative  
● Streets

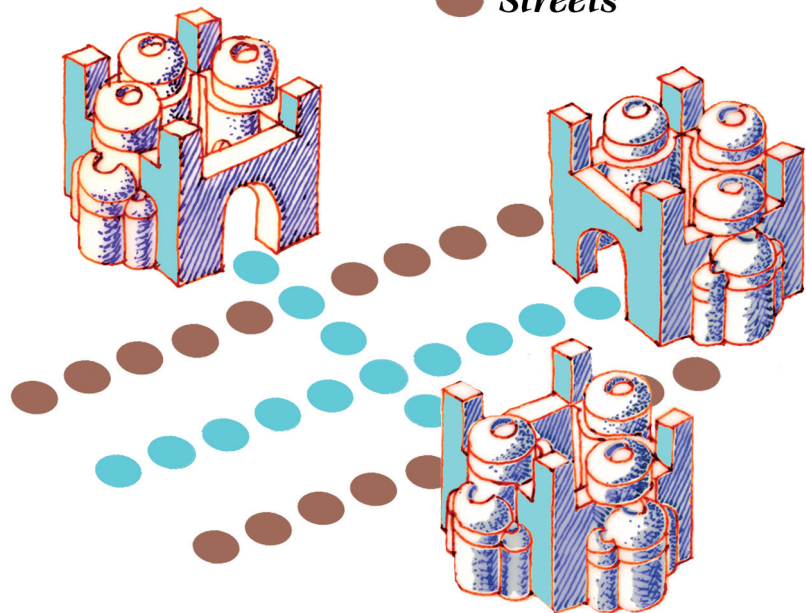

The 'Springing of Somatic and Sociatic Time as a Square framed by three 'Nymphaea'. The Rivers of Time emerge from these blocks, to run 'down-stream', off to the left, via the Event-Horizons of the Fluvial Narrative, to their Delta and the Ocean and the next most 'downstream' Nymphaeum etc.

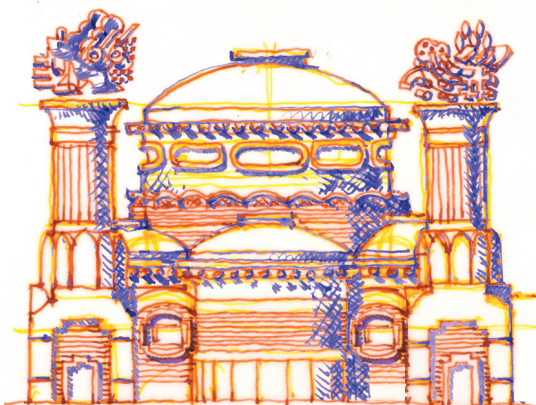

A small 'Nymphaeum', from 'upstream'. There is no door. The iconic axis of this building is inscribed as primarily vertical, discoursing the 'above' with the 'below'.



A 'Nymphaeum' can be signed by the Source-icon of three 'suns' rising between two mountains. The lowest sun that becomes the 'River' is the arch of the door.



A Nymphaeum building from 'down-stream'. The door orients the physical flow of Somatic/Sociatic time, making this the 'front' -and therefore 'social' and Urbane.

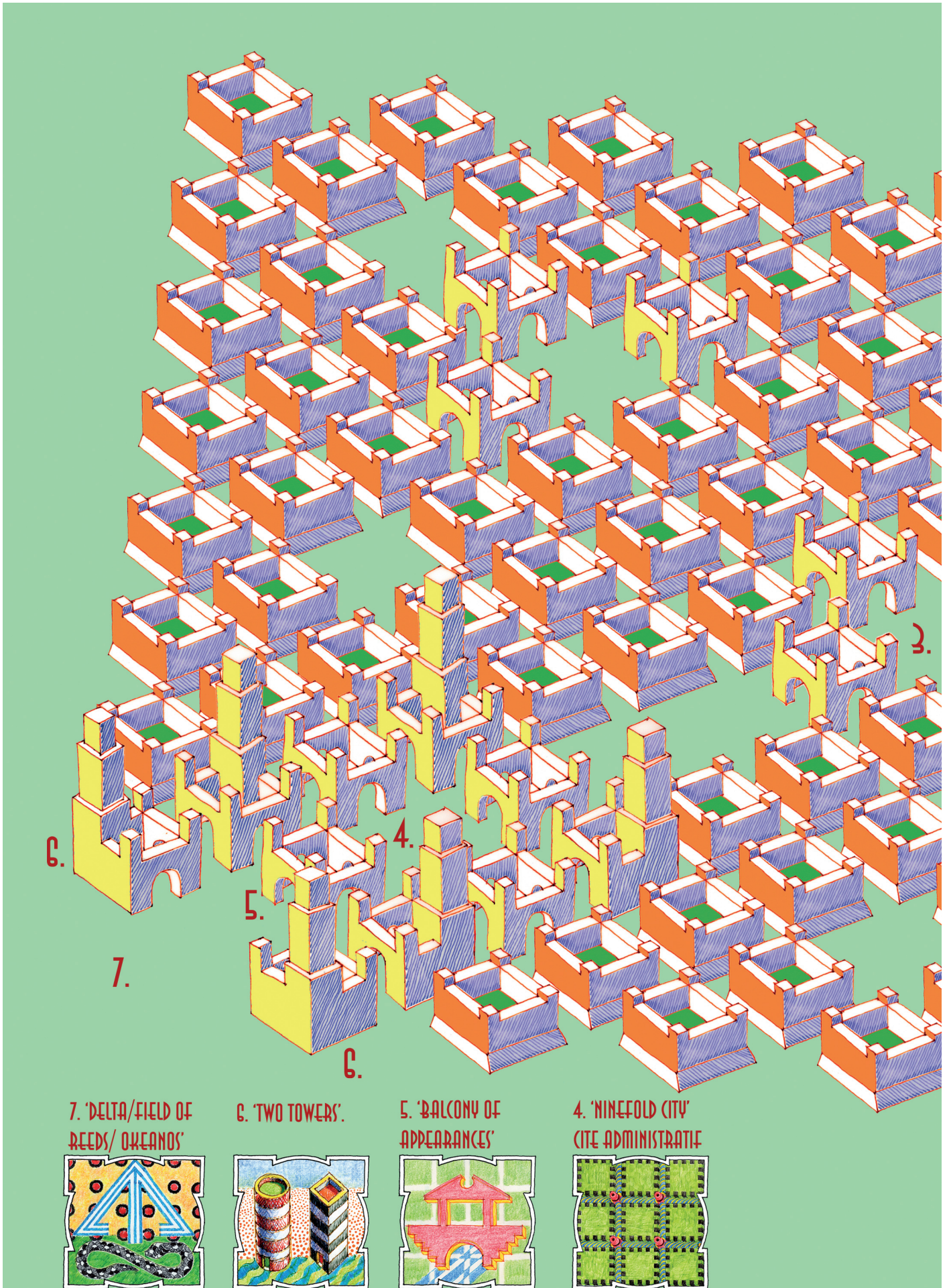

The 'ideal' theorised, diagram of either a small city or a 'Quarter' to a larger city. A city grows by adding such clear parts to itself, always doing so in groups of four, making what one might call 'towns' within the 'City-as-a-Whole.



3. CONFLUENCE/  
BAZAAR

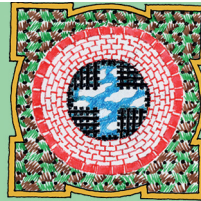

2. DISPLACED CROSSING  
PLACE DES POUVOIRS



1. 'SOURCE'/  
NYMPHAEUM

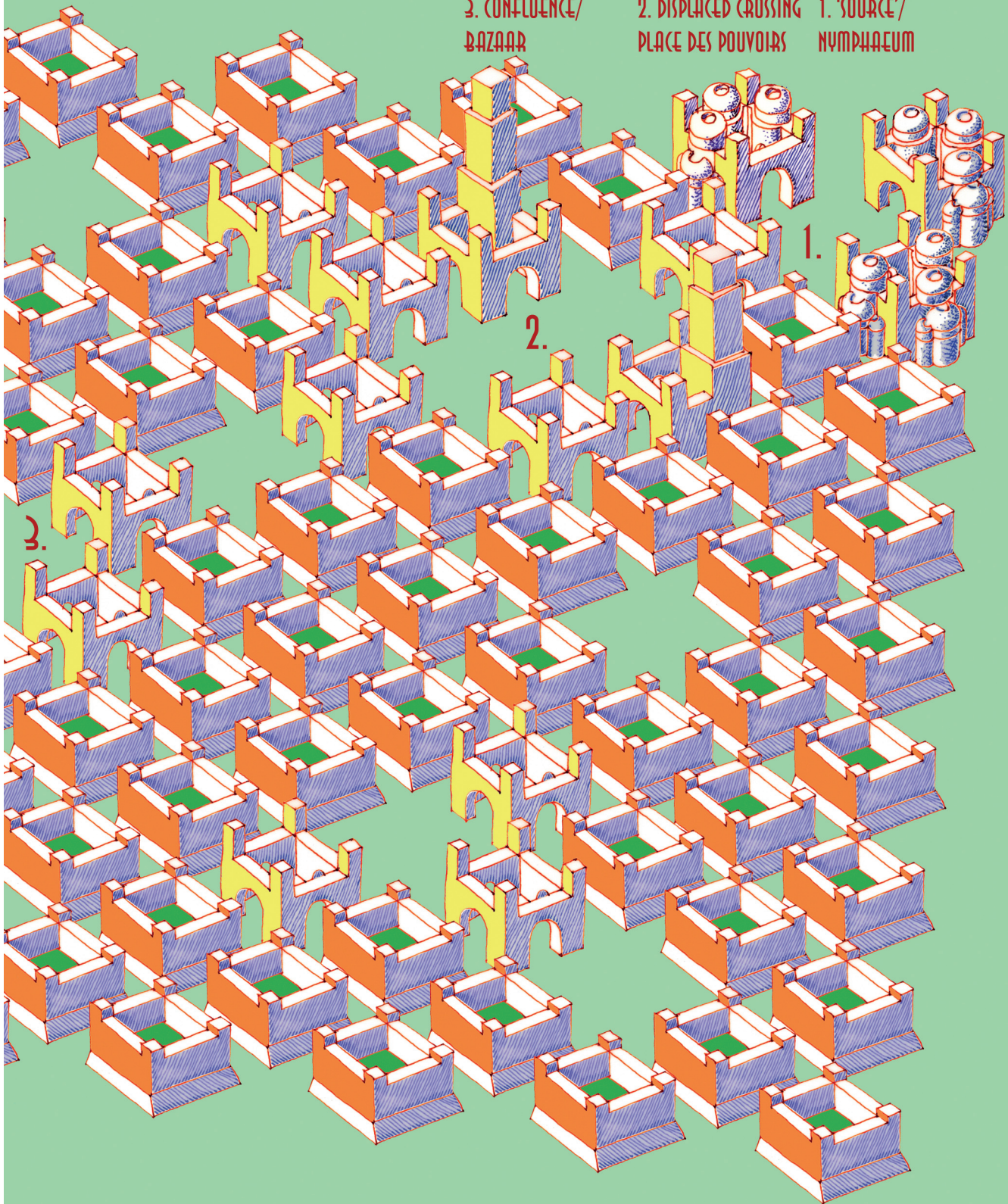

*One of the formal beauties of this topology, which flows the 'Republic of the Valley', of each Quarter, along its diagonals, is that a city, whatever size it becomes, is made of Quarters of properly self-regarding 'splendor'.*



I was flying to Rotterdam to be present at the unveiling of the miniaturised Groenmarkt and passed over the light reflecting off these beautifully 'unhumanised' Thames Delta marshes. From these I took the general form of an 'Estuary'. I recall drawing these estuarial forms at the age of twelve as I 'returned' from India at the age of twelve to a the 'homeworld' that I had never known before that age. They fascinated me.

I wanted to illustrate how the diagram shown on the preceding two pages could come to rest on a piece of real terrain. I was flying to Rotterdam at the time and we crossed the marshes of the Thames Estuary. They encouraged me to sketch an hypothetical parallel.

**WHAT FOLLOWED BROUGHT FORWARD AN IDEA WHICH HAS TENDED TO REMAIN HIDDEN BEAUSE OF ITS CONTENTIOSESS.**

For we may see, in the third illustration on this page, that the larger settlement is spined by an 'artificial' River - that of Somatic Time in its 'Republican' Valley, while the smaller one is spined by a 'real' waterway. Two larger waterways act as partial moats, further islanding the larger city.

*Is this larger entity the vision of a city that feeds itself from within itself and consumes, as one might say, 'It's own eco-smoke?' If this is so then is the smaller settlement the one that remains, as all settlements do today, physically connected and economically dependent upon the waters and other flora and fauna of the Estuary and Ocean?*

**Is this a legitimate vision?**

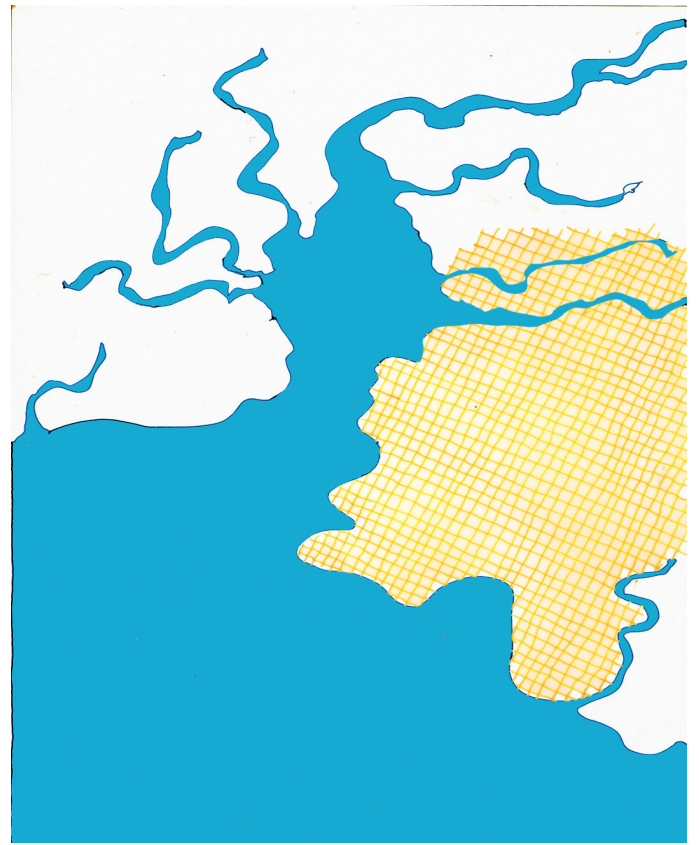

The site for the Constant City is quadrated. This is a process that has preceded Architecture for millenia upon millenia. The iconic collapse of the 20C is the first century that this effort would have been feared, if not even hated. For it engendeed the mortuary lifespaces imagined by Ludwig Hilberseimer and his many, 'Minimalist', imitators. In the case of the Constant City quadration is merely a useful, and invisible, infrastructure.

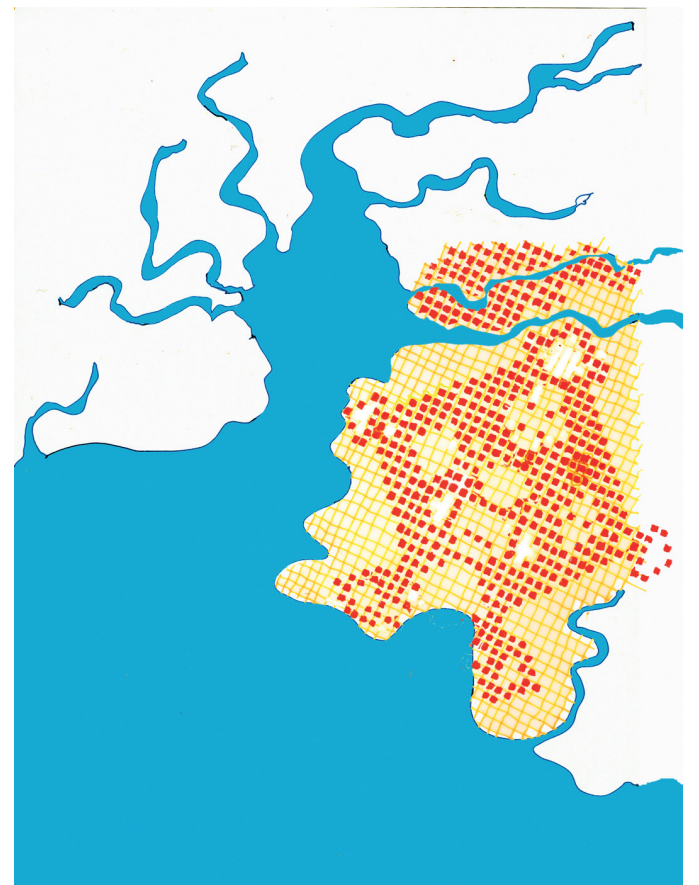



Whatever the degree and detail of the answer it is hard to avoid the thought that the Urbanisation of our species should be effected in ways that relieve the burdens we place upon the Ecosphere.

The 'Estuary' and Sea in this sketch should become more and more freed from at least those burdens of human interference which destroy its 'bio-mass'.

How can this be achieved unless humans achieve the ability to find what they need, at every level, within their own 'urbane' lifestspace?

Apart from this 'science-fiction' ambition, this slight drawing shows, in a simple plan shape, that the epiphanic axes, which define the meaning of the Quarter's lifestspace, run from vertex to vertex across the diagonals of the square.

One of the advantages of this diagonal quadration is that if three such Quarter-shapes are taken to meet at their Delta-Parks, which they may choose to merge into one larger 'central park', they could combine into a larger Quarter-unit which would then beg a further centralising 'downstream' quarter.

For what is built upon the quadration is 'pulchritudo splendor veritatis est'. The black-coloured blocks are the 'Fluvial'-type Isola-Blocks whose role it is to reify this ambition. They follow a narrative of Event-Horizons which, starting from the sea and walking 'upstream' comprise five Fluvial 'plazas'. These are: '1' The 'Delta-Park', '2' the 'Cité Administratif', '3' the 'Confluence-Market-Bazaar', '4' the Place des Pouvoirs and '5' the Place d'Origine-Nymphaeas. I use mainly French terms because Urbanité is so much more 'at home' in that culture. The cross-axes meet in the 'Confluence' and contain two plazas of similar provenance to the Place des Pouvoirs and the Nymphaea.

Through Town, and City up to Metropolis, the Constant City can grow and shrink while retaining its Qualities as well as its Physical Practicality. Four 'Quarters' combine into what one might call a 'Town'. Four of these could combine into what one might call a 'City' that would be sixteen times as large as the 'Quarter' illustrated in this Lecture.

This would combine all four into a figure of exactly the same beautiful geometry of 'ontological splendor' - but now four times as large.

And so on up to the size of a Metropolis - and all without destroying the 'Constancy' of the 'Constant City'.

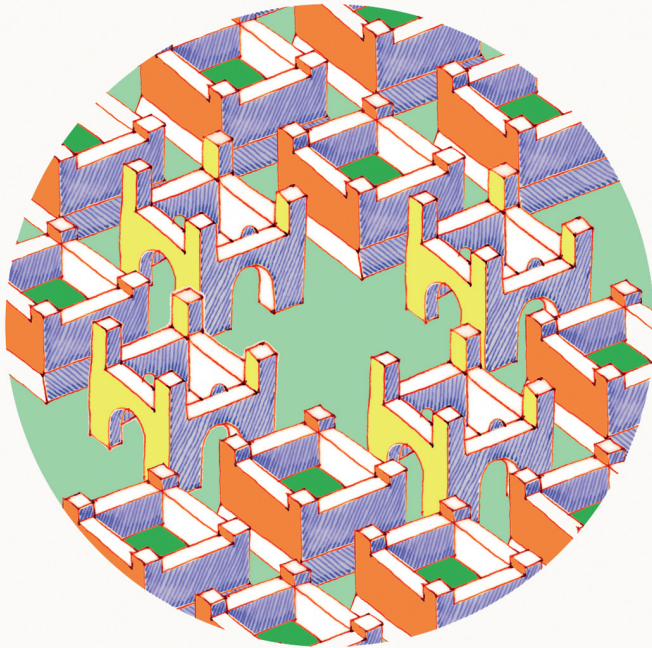

The Event-Horizon of 'Confluence' is located at the centre of the Quarter. It is shown made by four Fluvial-type Isola-Blocks each opened on one or more axes by a 'big arch'. I have suggested that it be used as a fresh produce market, with other functions attached. Fresh food is the quotidian focus of the Family and City.



I show the capital of my Isle of Dogs Pumping Station (1985) to provoke thoughts concerning the polychromy needed for the 'splendor' of iconic richness at the scale of a City.

than what is understood by it. Aesthetics is secondary to iconics. Both are there to serve the entity of the 'city' - something that enters through the senses but comes into full being by thought.

The 'decoration' of these buildings is critical.

The generic facade of a 'Fluvial Isola-Block' ...

I begin the 'fleshing-in' of a Quarter at its centre.

I call this the Event-horizon of 'Confluence'. It gathers-together the Arrows of Time issuing from the sundered quarters of the Heap of History. They are joined, under the 'Crossing', the central 'dancing floor' of the Republic of the Valley, into the River of the Somatic and Sociatic Time.



The icon of the River issues from the 'Confluence' that is the Threshing-floor/Chora.



A generic Facade for all Fluvial Isola-blocks has a city-scale central 'door' and taller corner-towers than the 'Handy-Square' isola. The beauty of the 'Eureka-Moment' is here apparent. Instead of slicing the social space in two, as was done in the Ville Radieuse, this

## ..is ordered with a 'Beaux-Arts Weave'.

This weave is a seven-fold one. It foregrounds its central sequence of courtyard-rooms and links them together via the 'doors' of the 'big arches' to provide sequences of spaces that house the city-wide Fluvial Narrative, the River of Somatic Time. They are flanked, on each side, by two rows of subsidiary rooms connected by corridors. These six corridors, and the entrances to them, pass through the 'yoke-bases' of Walking Order versions of the Sixth Order.

The mechanical road-traffic is pushed outside this 'Iconic River', passing down either side of it. Yet the Beaux-Arts weave allows these roadways to be integrated into a larger weave that can attach neighbouring blocks to the central river-complex. In this way achieving the nine-fold plot-plan of a major Event-Horizon.



*design-strategy, which one might call a Ville Fluviale, centralises the social space. But more important even than this rekindling of some sort of social-effect is the opportunity to inscribe an iconically-saturated 'river', via its Event-Horizon set-pieces, up through the 'valleys' of the city, linking all the Quarters into a Whole-City. Only this iconically coherent structure can, today, make a whole that is greater than its parts. Only a structure that appeals to to body and mind together has EVER been able to do this. This could be a 'City'*

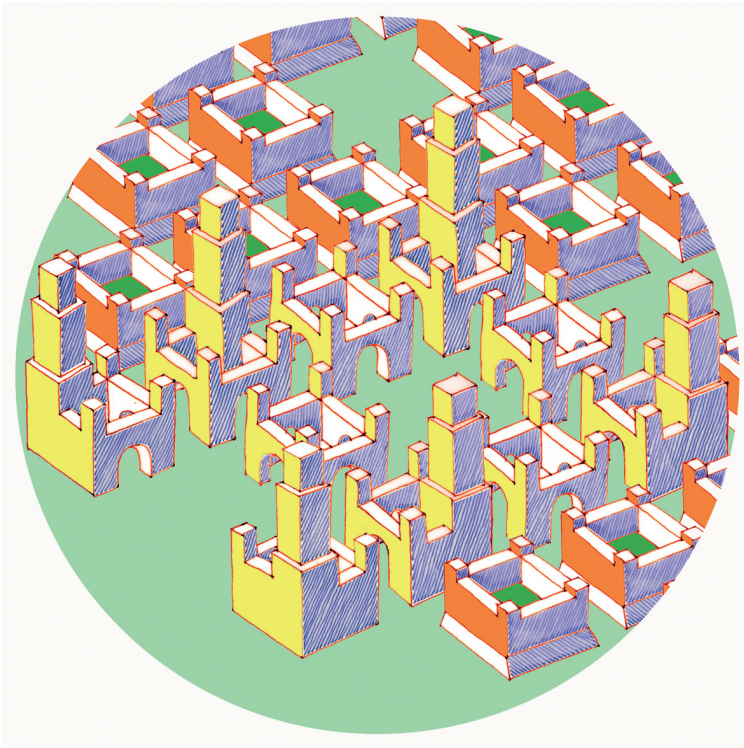

At the downstream end of the Valley of the Republic is found the Event-Horizon I call the 'City'. Its icon is the nine-fold square. Eight isola-plots surround a ninth. As in 'Confluence', this becomes the 'City's' Place of Appearances. Downstream of this Horizon is another such: the 'Place of the Delta'.

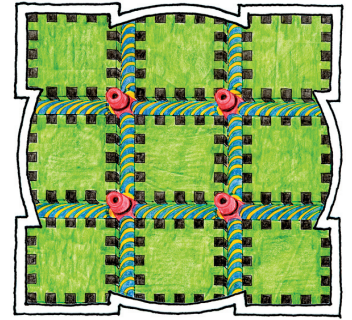

The Icon of the Event-Horizon of the 'City' is the nine-fold square.

'D' is for Delta, which could stand for 'Delta-City'. It shows the Nine-fold square of the 'City' attached by the 'Twin Towers' to the central isola-block' holding the position of the 'Balcony of Appearances' that overlooks the 'Delta' to the 'Infinite Ocean'. This composition of ten 'Fluvial-type Isola-Blocks, coded yellow, holds five of the Event-Horizons of Somatic Time. These total almost half of the commonest Horizons in the Fluvial Narrative.

Between them is a Fluvial Isola-block that stands in the position of the Balcony of Appearances.

My viewer will by now have noticed that there is such a 'balcony' over every Big Arch. This is correct. Every isola-block needs such a focal point, even when each apartment in a handy-square has one of its own. A city is both a public and a private place. Balconies are for public events and there can never be too many of them. If there is only one balcony in a city, it will be a city of subjects under a monarch. In a city of many balconies, such as I propose, the one for its Mayor, or its appointed administrator, may be no bigger, better or more splendid than any of the others. It will however, be in a particular place. It is the office, not the person who fills it that distinguishes constitutional from dynastic politics. There will be only one balcony for the Mayor, but many persons who can and will, each in their turn, come to stand on it.

Further to the edge of the Weave is the proposal to plant forest-size trees along the central reservation of these main streets. Such trees grow to 30M North of the Alps. They must be given room to spread into their natural shape. Planting them close to buildings can lead to them being pollarded, which is ugly. Smaller trees can be planted, for shade, in the footways, for the first thirty years. But, after this, when the forest trees have spread, it may be advisable to move them. Thirty years is nothing to the life a town or a city with ambitions to be 'more than its individual components'.



This view is looking 'Downstream' from the Confluence, or Central Market. The three arches under the 'Balcony of Appearances' can be seen on the far side of the courtyard. Beyond them lies the 'Delta' and then the 'Ocean (Park)'.



*The iconic richness of a Graphic far exceeds both Sculpture and Architecture. The soffite of its 'Big Arches' are the places to script an Event Horizon. Donors to urban instruments of such importance, like this first design for the Judge ceiling, are never hard to find. JOA's already proved, in Texas, an inexpensive technology for such 'scriptings'.*



*My listener should not believe that it is necessary to give the same appearance to all of the Fluvial Isola-blocks in the Republic of the Valley. What is needed is only an architecture which can 'reify ideas'. The principal advantage of the diverse traditions which I include in the Architecture of a Sixth Order', is that they have been, in their various ways, done just that. They included ideas, epiphanically, within quotidian space. Combined and modernised, Architecture can continue to en flesh ideas - more effectively than before. The medium needs no further conceptual horsepower. If Architecture, as the gross disposition of built elements, becomes an end in itself it ends in stupidity.*

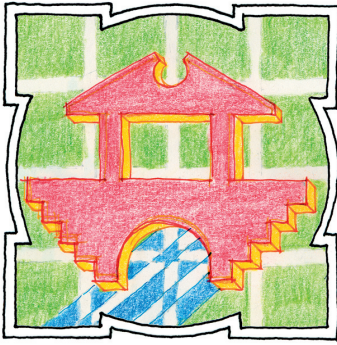

The icon of the Balcony of Appearances is flanked by 'steps' and admits the River of Somatic Time through an Arched Door. It fronts the City and overlooks the Delta, a space that is shared by its two neighbouring Quarters. The Delta is part urban park and part urban stage, upon which are played the large spectacles viewed from all sides and levels.

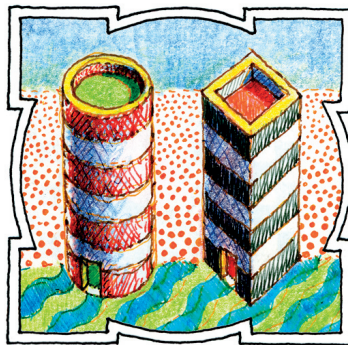

The Two Towers flank the Balcony of Appearances to signal the Gate to the Republic of the Valley. Their horizontal stripes also sign a more general iconology, common to all buildings of the Sixth Order, where the cataclysmic Advent of the Time of Inception creates a Camera Lucida between the four corners of the quartered Heap of History.

The Event-Horizon of the City is the last one in the Fluvial Narrative of the Republic of the Valley that looks inward to the Quarter in which it is built. The next one downstream is the Balcony of Appearances. This sits between the 'Two towers' and both looks over and is seen by the Delta and the Infinite Ocean.

**These last three Event-Horizons combine with those of their two neighbours to make up a Park of the Delta-Ocean - typically the largest public space in a 'Whole City'. It is used to stage spectacles, using mechanical marionettes, such as that performed in central London in 2006, drawing great crowds into an atmosphere of congeniality that was, nevertheless structured by a narrative programme.**

***The Delta-Ocean Park is a theatre in which the Quarters reify themselves as actual, real, and 'presenced'.***



The **Park of the Delta-Ocean**, combines three 'Events'. It is a 'Delta', a 'Field of Reeds' and an 'Infinite Ocean'. It combines with the 'Delta-Parks' of the two neighbouring Quarters, making-up what is, typically, the largest sort of space in the Whole City. The Field of Reeds signs that this, like any columnar portico, is an Hypostylar 'entrance-field' in which the 'exterior' is erased and the spirit re-set to engage with the internal Republic of the Valley of the Quarter being entered, or, for that matter, left. The Delta, laid over this Hypostylar Infinitude, signs a field of erasure and rebirth. It disperses into the Infinite Light that is the Ocean. It converges to enter the Republic of the Quarter through the Arched Door between the Quartered Towers of History and under the Balcony of Appearances.

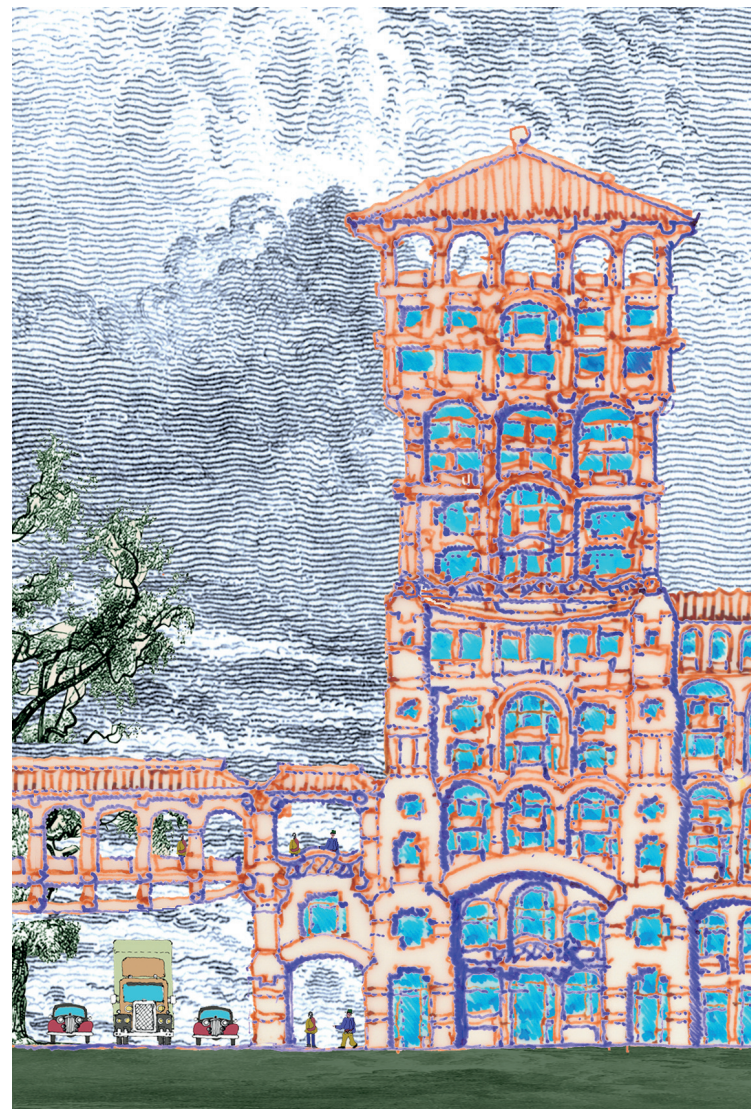

This view shows the Isola-block of the Balcony of Appearances as seen from the Place of the Delta. This is the particular balcony, amongst the many found all over the City of the Sixth Order on which stand the 'Eminenti' of a Quarter.



*A giant, hydraulically-powered, mechanical elephant controlled by 'pilots' sitting on it and under it moves gently amongst the throng of participants. The event shows the scale of the spectacle which can be achieved and more important than that, the practicality of an iconically scripted relationship between relatively large numbers of people.*



*The 'Gamine' A giant child walks amongst the crowds in London on 4-7 May 2006. She is controlled by her French attendants of the company 'Royal de Luxe' and is going to meet the 50-ton Elephant. The Machines resemble those used by Europe during the Renaissance, when 'masques' were performed by and for whole cities.*



*The sketch shows balcony-bridges over the roads. Their main function is to make of the tri-partite Park of the Delta-Ocean a theatrical, outward-looking place in which it would be natural to stage large spectacles in which the Quarters, and their diverse institutions, would be able to actualise themselves.*

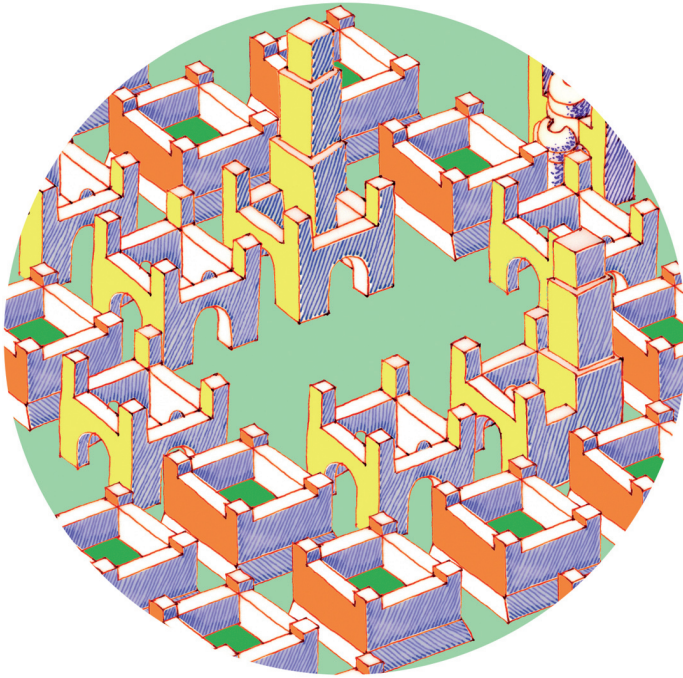

The Place of the Powers. The 'classic' Separation of Powers is symbolised by placing the Law-givers and the Judges opposite each other. They frame the Executive. The Place of the Powers should also contain the 'Mind of the Plaza' In the shape of coffee-shops and bars in which Public Opinion is openly argued and articulated.

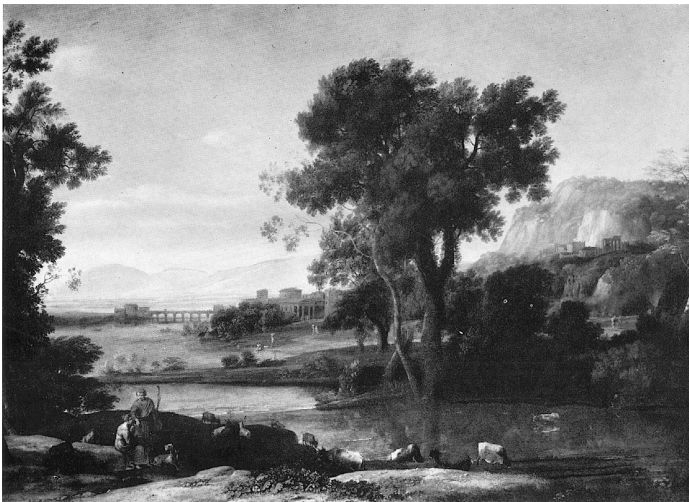

The privileged position of being the 'Viewer' allows us to take-in the whole 'Valley'. The other Event-Horizons of the Valley can be posited to exist within a phenomenology of Claude's fluvial metaphor. The Place des Pouvoirs does not. So he did not paint it. However, when juxtaposed to the other pole of the metaphor that I propose, that of the phenomenology of an urban Quarter, then the 'Valley' as a painting, with both Painter and Viewer, becomes the theatre in which this idea of a city as a Republic of the Valley is given epiphanic being.

This 'clue', when translated to the Romanesque Cathedral, mapped onto the **apsidial amphitheatre** found, **upstream of the central crossing**, in the architecture of the Church. This was **not the solitary 'cathedra' of the Bishop**. It was the **amphitheatral seating** of the whole clergy of the Cathedral.

The study of Ernest Hébrard's early 20C Beaux-Arts Plan for the rebuilding of Thessaloniki revealed an essential component of the Democratic, Modern, City that appeared to be impossible to map onto the succession of fluvial Event Horizons so prophetically articulated in the 17C landscapes of Claude Geleé.

The 'Place des Pouvoirs' was absent!



We, the Viewers of Claude's painting of 'A Landscape with Nymph and Satyr dancing', stand in the position of Hebrard's Place des Pouvoirs - above the 'Chora-Crossing-Confluence' and below the 'Source'..

This disappointed me, for it was the 'metaphoric' incongruity of finding the narratology of a landscape, filled with plants and water, in the cut and polished stone of buildings - and vice-versa - that testified to its 'information-value' as a Phenomenology of Somatic Time. I puzzled over this lack until it came to me that it was we, Claude's spectators, who were the 'Empowered Ones'. Claude's landscapes placed his Viewers slightly above the Chora of the 'Confluence', yet below the 'Source' of his axial river. This was exactly where Hebrard placed his Place des Pouvoirs.



They saw the congregation of the Ecclesia and the Public of the Ecclesia saw them.

# I took this 'Theatral Form' as the icon of the Place of the Powers.

It seemed a *good analogy* of the role of the *democratic government* of a *City*. *Cities* should no longer grow up in the shadow of an autocrat, whether *clerical, secular* or merely dictatorial in the 20C manner. They should no longer be the *plaything* of a *Bishop* or a *Prince*. They should be conceived as *autonomous political and economic entities*. Their *government* should arise out of its citizens - who seek to *guide themselves* towards a more effective *state of Being*. Such a *style of Government* not only has to 'have a view' of the *City-as-a-Whole* but has to be 'in view' of the city, and its *citizens*, as it seeks to *govern its fortunes*.

If we view *Claude's landscape* of the geography of *Somatic time* to be the *phenomenology of a human life* then we *look*, in effect, upon a *city that is ourselves*. In so doing we become *conscious of our own nature*.

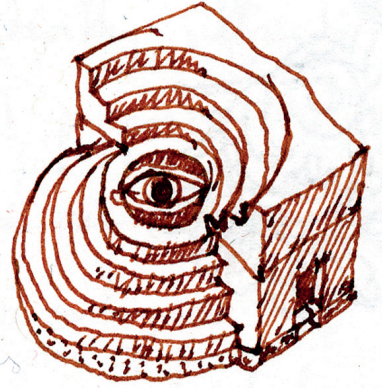

The *City* should be the same. An *entirely human institution*, its 'self' is its *citizens*. The '*Place des Pouvoirs*' is the *City's Government*. Its *Lawmakers Judges and Executive* are its *consciousness of itself*. They *act*, as *do we ourselves, self-consciously*.

The fact that this aspect of *Hebrard's Plan* remains the most patently unrealised part of his *New Thessaloniki* can be taken, as I do take it, as *evidence of the collapse of City Planning theory during the 20C*, and, consequent to that, the equally catastrophic collapse of the theories of *Architecture and Decoration, or Iconic Engineering, needed to reify ideas at the scale of a City*.

I show no larger-scale sketches of the *Place of the Powers*. I have done sufficient for the other *Event Horizons* for my *Listeners* to *imagine their general disposition*. Every structured invention has its *sumptuary laws*. The *Architecture of the Theatre of the City-Government* should be the most profound and reflective in their *Quarter*. It is the place in which the '*Soul of the Quarter*' is *mediated*.

The *Place of the Powers* is not the *Quarter* itself. It is the place in which the *Quarter* is rendered into *Reason*. It is the place where it is '*thought*'. Yet just as *thinking* is never disembodied, or disengaged from its object, so does the *Place of the Powers* still remain enfolded in the *River of Somatic Time*. It still feels the beating of the blood that *instituted Time* upon the deathless infinitude of the *Proton Chronon*, the *timeless Time before Time* of the *Hypostylar forest of infinity*.

*My inclination is not, therefore, as with the others, to dash-out a design as a quick sketch.*

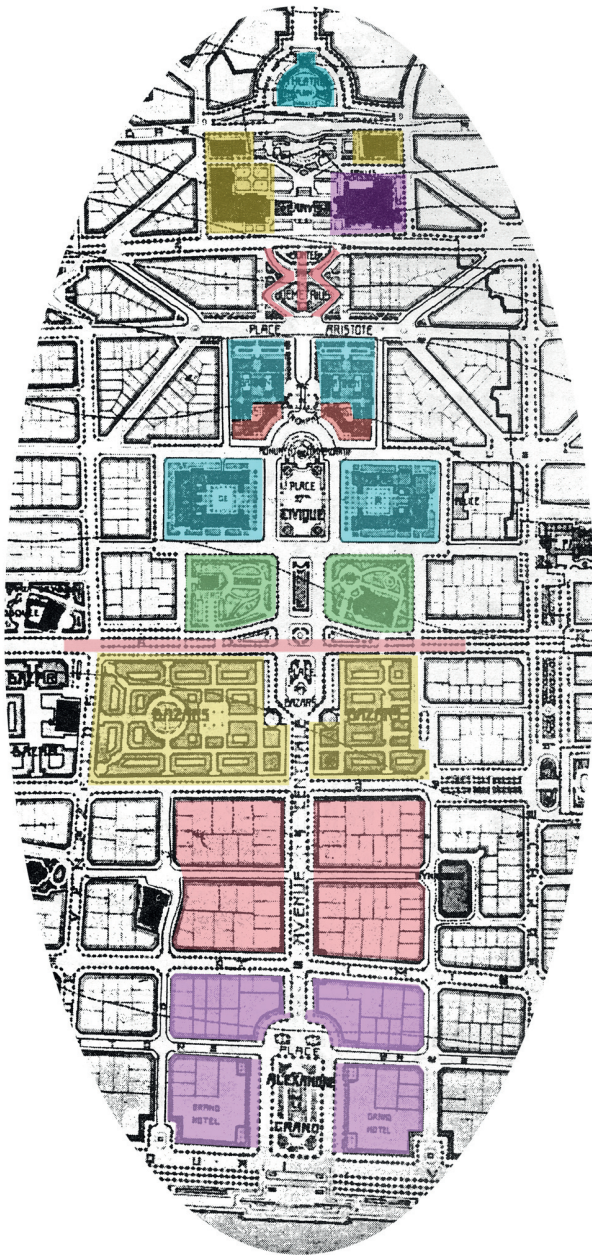

Hebrard's 1919 plan for the Republic of the Valley of the city of Thessaloniki shows a *Place des Pouvoirs* in pale blue with its *Mind of the Plaza*, in pink. It has not yet been built. How could it be when the very idea of a self-governing city collapsed into the cold-war choice between dictatorship or anarchy.

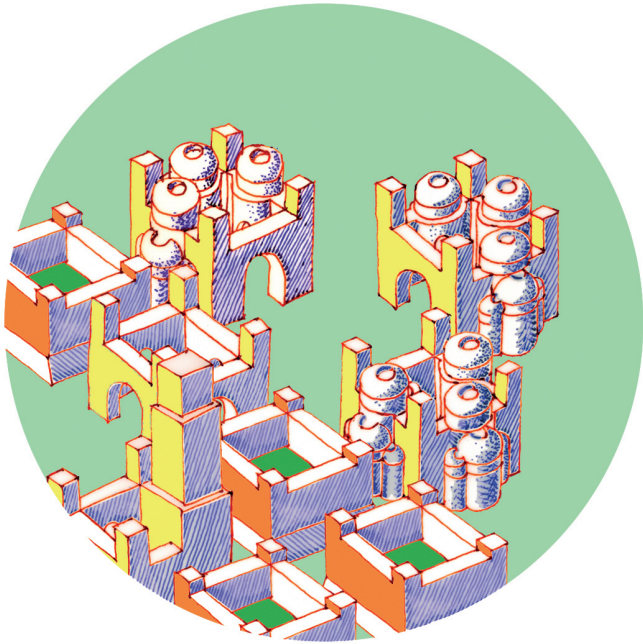

The Event-Horizon of Source is located at the Head of the Valley. A Fluvial-block uses its 'big arch' to form a doorway into the Square, or Place, of the Source made by three Nymphaeum-Blocks.

The Source is the spot where this advent births the temporal stream of a Whole-Quarter, and even, on the largest scale - that of the Whole-City.

**Not that this 'Source' need be in any way singular. The Whole-Quarter-diagram shows three 'Source' isola-blocks.**

The Icon of the Confluence, which I proposed as the Central Market for this Quarter, shows three Tumbling Streams, in black, yellow and red, from three Sources, one at each of three diagonal extremes of the Quarter. If we merely adhere to the simple geometry of this we can generate nine 'Source-Blocks'! With such numbers no source, no medium and no 'tradition' need be excluded.



The Event-Horizon of 'Confluence' shows red, black and yellow Streams "tumbling" from three Sources.

## The 'Sources' can be entirely Various.

A globalised culture must preserve its ancient origins and distinctions. This can be achieved by an Architecture such as that of the Sixth Order, which is designed specifically to be the bearer of ideas which it can reify to accompany any rite, be it arcane or quotidian. These can then be inscribed down the Republic of the Valley of a City-Quarter to make it the conceptual and ritual home of whatever culture chooses to 'colonise' it.

The last Event-Horizon in this brief over-view of a Quarter's 'Valley' is that of its 'Source'. Every human institution was founded by an historic person or body of persons. But, as the Institution develops, the founding act is transformed into a Constitution. Other Event-Horizons can look two ways, back to the past, 'upstream' and forwards to the Future, 'downstream'.

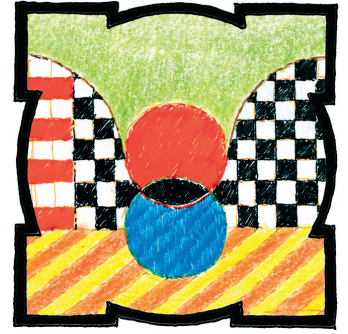

The Event-Horizon of 'Source' signs an hydro-logical cycling out of a black cave-spring from a mountain that intersects red sun and blue water.

The Source can look only forwards, 'down' to the Future. Its past has no horizontal axis on which a human foot can trace the spatial narrative which Corbusier named the 'promenade architecturale'. It is for this reason that its constitutive buildings, in the diagram of the Whole Quarter, have domes and oculi. At the Source, only the vertical, of the six axes of human being, remains palpable. Every building, and every isola-block, begins with the catastrophic coincidence of the Raft of Reason with the Heap of History.

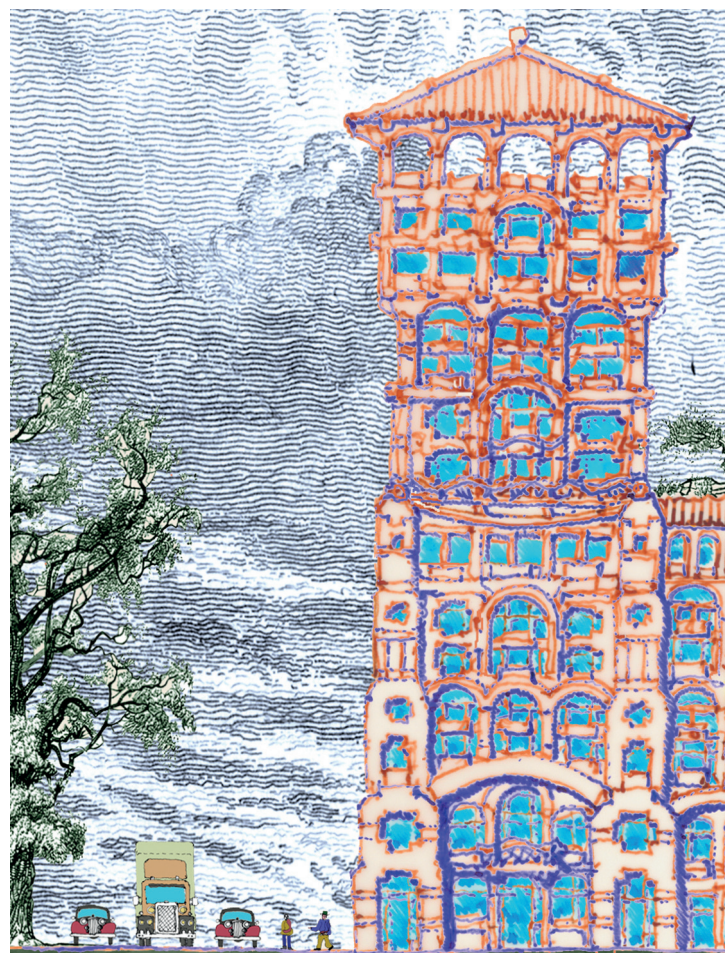

I term the Source-Buildings 'Nymphaea' to generalise them beyond their Ancient typology of tomb, temple and church. This shows a typical Fluvial Isola-Block at the Source. The Nymphaeum, shown in L.34, is visible through the 'Big Arch' of a Whole-Quarter-scale door..

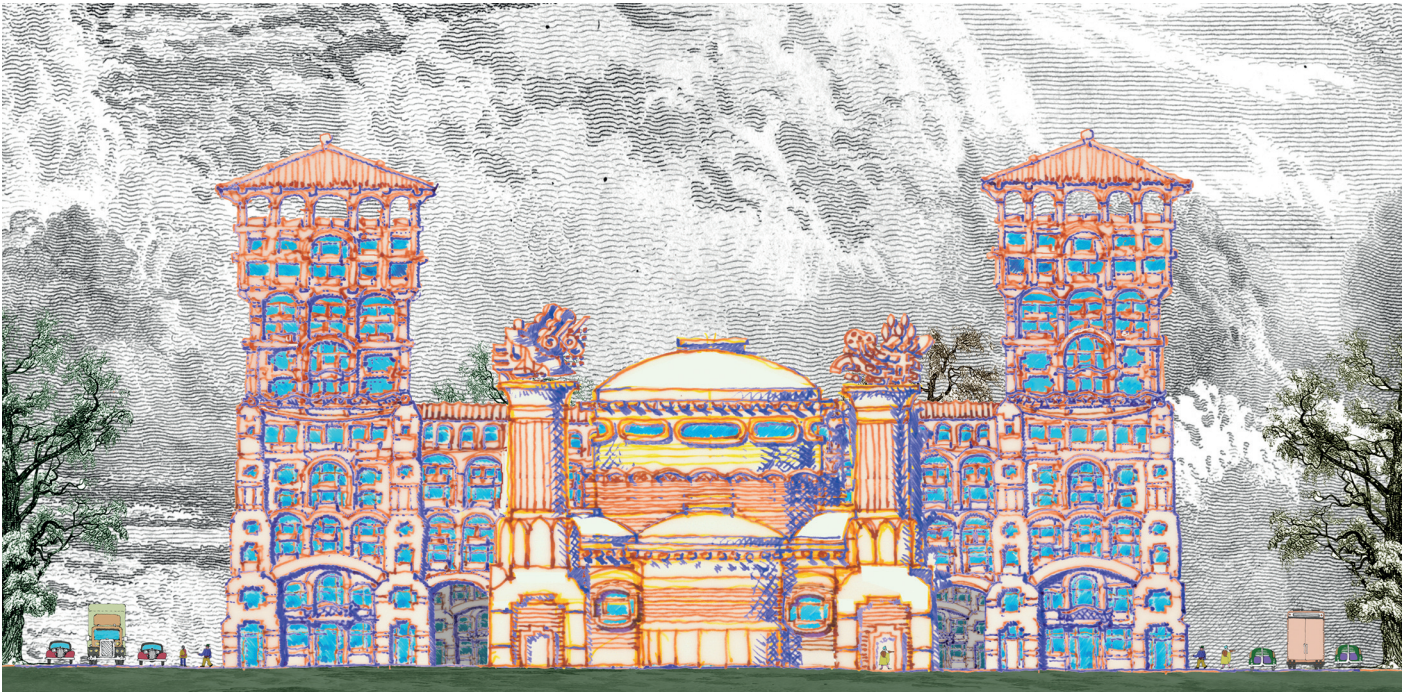

*The view of a Fluvial Isola-block looking 'downstream' from the Park of the Delta-Ocean made from the meeting of three 'upstream' neighbour-Quarters. This park 'ends' in an Okeanos, which, if rendered as a lake, could be a suitably marine setting for the central Nymphaeum Block of the 'downstream' Quarter that it, in turn, 'sources'.*



*An Architecture for one of the three Nymphaeum-Blocks This is the only Fluvial Block that blocks the horizontal flow of the River of Time. This is because 'Somatic Time', sources separately in each Quarter. Each Quarter is a separate 'cultural' or 'ethological' zone. This polyzonal concept is a response to the cultural simultaneity brought by 'globalisation'. Each can centre itself on an ancient, archaising or 'original' cultural tradition. Each will, inevitably, relate to all the others through the syncretic culture of the City-as-a-Whole that must be inscribed within its Terminal Quarters. There will be a competition, at this Whole-City level, between all the constituting Quarters. But this cultural combat will rest on the secure foundations of each culture's Home Quarter.*

## **AFTERWORD: THE FORTY-FIRST LECTURE: REPUBLIC OF THE VALLEY.**

*JOA only built once on what the British call "the Continent" in the sense of "Fog in Channel, Continent isolated". The project was well done, except for the ceiling, where we were studiously ignored by a commercial, but very civil Client who 'collected art'. I am told he subsequently regretted this off-handedness. The way it was built also ignored everything JOA had done, and learnt, over thirty years, with predictable results on the project's timeline and Contractor's profits.*

*But the Public, who called it the Candy-box, loved it so much that they 'voted' to shrink it and put it, at 1:15 scale, into Madurodam, a miniaturised Holland complete with Schipol Airport, canals, trams, music-playing opera houses and all, built in the memory of a Jewish man, from Curacao, whom the Nazis killed in Auschwitz. The Public, as they always have, such as when they gave the internally-damaged Judge the decennial prize in Cambridge, supported an Architecture that did not treat them like illiterates, fit only to be watered and heated like vegetables ready for cropping. Groenmarkt had 'Become an Idea'.*

*A trip to New York in 2009 revealed a brilliant moment in the history of the 'skyscraper', when the Beaux Arts Weave was not yet dead in American Architecture. Not that it is entirely dead today. In 2003 the small, and local, New York firm of Peterson/Littenberg submitted an invited entry to the 'Ground Zero' Competition for the site of 9/11 which showed a continued understanding of its principles of 'weave'. It goes without saying that the late Herbert Muschamps, the sycophantic Architecture Critic of the New York Times, seeking to please his 'friends' the Starchitects, all of whom proposed buildings of a gratuitous ugliness and urban illiteracy, went out of his empurpled way to denigrate the urbane civility of the Petersom/Littenberg design.*

*I thought hard about whether to go any further with these unfashionable ideas concerning what was becoming the design of an Ideal City. The bigger the scale the less time there is to 'fill-in' the all-important detail. But then, I thought to myself, what better opportunity will I have to make very broad and sweeping 'theoretical' generalisations than in Lectures which have already demonstrated in some detail, that detail can always, and I repeat always, 'humanise' the largest idea. The idea is the End, the detail the Means.*

*If anyone is frightened by the rigour of the last few pages remember that they are design principles which, when applied in the circumstantial world must, as happened in the Judge Institute, and to lesser extent in Duncan Hall, always require those variations and compromises whose solution is the test of a designer's capability to 'rise to the occasion'. Responses to obstacles make for the 'tragic' in any situation. This is why a finished building should always be better than a paper design. The workings of matter reveal the beauty of ideals.*